



**ResMed**

**AirSense™ 10**

AUTOSET

AUTOSET FOR HER

ELITE

PLUS



Clinical guide  
English

# Contents

- Welcome** ..... 1
  - Indications for use ..... 1
    - AirSense 10 AutoSet Plus ..... 1
    - AirSense 10 AutoSet for Her Plus ..... 1
    - AirSense 10 Elite Plus ..... 1
  - Contraindications ..... 1
  - Adverse effects ..... 2
- At a glance** ..... 2
- About the control panel** ..... 3
- Therapy information** ..... 4
  - AutoSet mode ..... 4
    - Normal airway ..... 4
    - Flow limitation ..... 5
    - Snore ..... 5
    - Apnea ..... 5
  - AutoSet for Her mode ..... 7
  - CPAP mode ..... 7
  - Reporting ..... 8
    - Central sleep apnea detection ..... 8
    - Cheyne-Stokes respiration detection ..... 8
    - Respiratory effort related arousals reporting ..... 9
- Comfort features** ..... 10
  - Ramp ..... 10
  - Expiratory Pressure Relief ..... 10
  - AutoSet Response ..... 11
  - Climate Control ..... 11
    - Climate Control Auto ..... 11
    - Tube Temperature ..... 11
    - Climate Control Manual ..... 11
    - Tube Temperature ..... 11
    - Humidity Level ..... 12
- Setup** ..... 13
  - Supplemental oxygen ..... 14
  - Antibacterial filters ..... 14
- Accessing and exiting the Clinical Menu** ..... 14
  - Adjusting the clinical settings ..... 15
    - Setting the date and time ..... 15
  - Settings menu ..... 16
    - Therapy ..... 16
    - Comfort ..... 16
    - Accessories ..... 17
    - Options ..... 17
    - Configuration ..... 18
- Starting therapy** ..... 19
- Stopping therapy** ..... 19
  - Viewing the Sleep Report ..... 19
  - Sleep Report screen parameters ..... 20
- Cleaning and Maintenance** ..... 21
  - Disassembling ..... 21

Cleaning .....	21
Checking .....	22
Reassembling.....	22
<b>Reprocessing.....</b>	<b>22</b>
Surface disinfection .....	23
Reprocessing the air tubing and Air10 tubing elbow .....	23
Disconnecting .....	23
Decontaminating .....	24
Disinfecting .....	24
Inspecting .....	25
Reconnecting the air tubing.....	25
Packaging and storage.....	25
Reprocessing the humidifier and air outlet.....	26
Disassembling.....	26
Decontaminating.....	27
Disinfecting.....	27
Inspecting .....	28
Reassembling.....	28
Packaging and storage.....	29
<b>Data management and therapy compliance .....</b>	<b>29</b>
SD card.....	29
Data storage .....	30
<b>Managing patient care.....</b>	<b>30</b>
Patient menu .....	30
Traveling.....	30
Traveling by plane.....	31
<b>Troubleshooting.....</b>	<b>31</b>
General troubleshooting .....	31
Device messages .....	33
<b>General warnings and cautions .....</b>	<b>34</b>
<b>Technical specifications.....</b>	<b>35</b>
Symbols .....	39
Servicing.....	39
Limited warranty.....	40

# Welcome

The AirSense™ 10 AutoSet™ Plus and AirSense 10 AutoSet for Her Plus are ResMed's premium auto-adjusting pressure devices. The AirSense 10 Elite Plus is ResMed's Continuous Positive Airway Pressure (CPAP) devices.

## WARNING

- Read this entire guide before using the device.
- Use the device according to the intended use provided in this guide.
- The advice provided by your prescribing doctor should be followed ahead of the information provided in this guide.

## Indications for use

### **AirSense 10 AutoSet Plus**

The AirSense 10 AutoSet Plus self-adjusting device is indicated for the treatment of obstructive sleep apnea (OSA) in patients weighing more than 30 kg. It is intended for home and hospital use.

The humidifier is intended for single patient use in the home environment and re-use in a hospital/institutional environment.

### **AirSense 10 AutoSet for Her Plus**

The AirSense 10 AutoSet for Her Plus self-adjusting device is indicated for the treatment of obstructive sleep apnea (OSA) in female patients with mild to moderate OSA weighing more than 30 kg. It is intended for home and hospital use.

The humidifier is intended for single patient use in the home environment and re-use in a hospital/institutional environment.

### **AirSense 10 Elite Plus**

The AirSense 10 Elite Plus device is indicated for the treatment of obstructive sleep apnea (OSA) in patients weighing more than 30 kg. It is intended for home and hospital use.

The humidifier is intended for single patient use in the home environment and re-use in a hospital/institutional environment.

## Contraindications

Positive airway pressure therapy may be contraindicated in some patients with the following pre-existing conditions:

- severe bullous lung disease
- pneumothorax
- pathologically low blood pressure
- dehydration
- cerebrospinal fluid leak, recent cranial surgery, or trauma.

## Adverse effects

Patients should report unusual chest pain, severe headache, or increased breathlessness to their prescribing physician. An acute upper respiratory tract infection may require temporary discontinuation of treatment.

The following side effects may arise during the course of therapy with the device:

- drying of the nose, mouth, or throat
- nosebleed
- bloating
- ear or sinus discomfort
- eye irritation
- skin rashes.

## At a glance

The AirSense 10 Plus includes the following:

- Device
- HumidAir™ humidifier
- Air tubing
- Power supply unit
- Travel bag
- SD card (already inserted).

A range of accessories are available for use with the device including:

- Air tubing (heated and non-heated): ClimateLineAir™, SlimLine™, ClimateLineAir Oxy, Standard
- Side cover for use without the humidifier
- Filter: Hypoallergenic filter, standard filter
- Air10™ DC/DC converter (12V/24V)
- SD card reader
- Air10 oximeter adapter
- Air10 USB adapter
- Power Station II
- Air10 tubing elbow.

Note: Make sure all parts and accessories used with the device are compatible. For compatibility information, refer to [www.resmed.com](http://www.resmed.com).

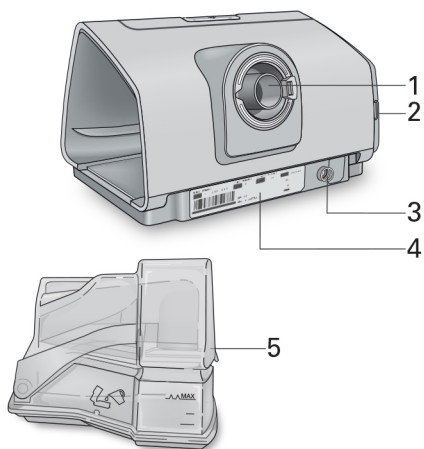
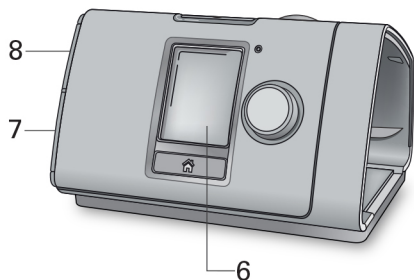

- 1 Air outlet
- 2 Air filter cover
- 3 Power inlet
- 4 Serial number and device number

- 5 HumidAir humidifier
- 6 Screen
- 7 Adapter cover
- 8 SD card cover

## About the control panel



Start/Stop button

Press to start/stop therapy.  
Press and hold for three seconds to enter power save mode.



Dial

Turn to navigate the menu and press to select an option.  
Turn to adjust a selected option and press to save your change.



Home button

Press to return to the Home screen.

Different icons may be displayed on the screen at different times including:



Ramp Time



Wireless signal strength (green)



Ramp Time Auto



Wireless transfer not enabled (gray)



Humidity



No wireless connection



Humidifier warming



Airplane Mode



Humidifier cooling

# Therapy information

The following modes are available on the AirSense 10 Plus device:

Device	Modes available		
	AutoSet	AutoSet for Her	CPAP
AirSense 10 AutoSet Plus	✓		✓
AirSense 10 AutoSet for Her Plus	✓	✓	✓
AirSense 10 Elite Plus			✓

## AutoSet mode

The treatment pressure required by the patient may vary due to changes in sleep state, body position and airway resistance. In AutoSet mode, the device provides only that amount of pressure required to maintain upper airway patency.

The device analyzes the state of the patient's upper airway on a breath-by-breath basis and delivers pressure within the allowed range according to the degree of obstruction. The AutoSet algorithm adjusts treatment pressure as a function of three parameters: inspiratory flow limitation, snore, and apnea.

### Normal airway

When the patient is breathing normally, the inspiratory flow measured by the device as a function of time shows a typically rounded curve for each breath.

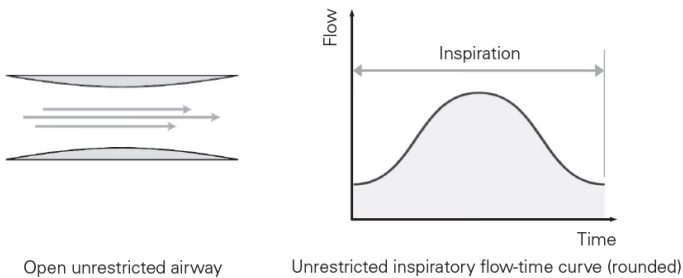

### Flow limitation

As the upper airway begins to collapse, the shape of the inspiratory flow-time curve changes. The AirSense 10 Plus recognizes and treats traditional as well as less common flow-limited breath wave forms.

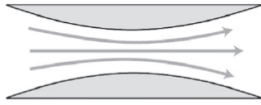

Silent partial airway obstruction

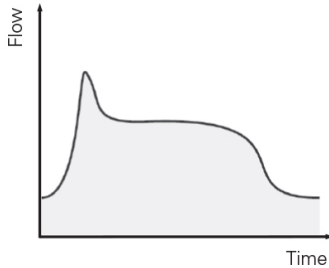

Flattened inspiratory flow-time curve (denoting partial obstruction)

### Snore

Snoring is sound generated by vibrations of the walls of the upper airway. It is often preceded by flow limitation or a partial obstruction of the airway.

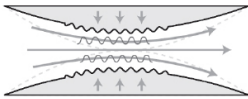

Noisy partial airway obstruction

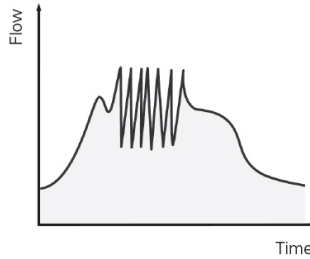

Snore superimposed on inspiratory flow-time curve

### Apnea

The enhanced AutoSet algorithm detects both obstructive and central apneas. If an apnea occurs, the device responds appropriately.



## Obstructive apnea

An obstructive apnea is when the upper airway becomes severely limited or completely obstructed. AutoSet generally prevents obstructive apneas from occurring by responding to flow limitation and snoring. If an obstructive apnea occurs, the device will respond by increasing pressure.

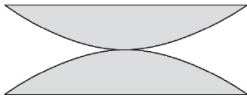

Complete airway obstruction

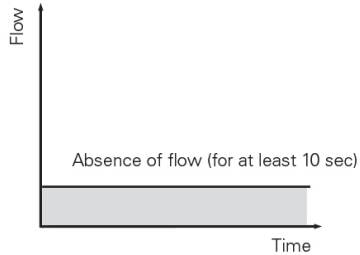

Inspiratory flow-time curve

## Central apnea

During a central apnea, the airway will remain open, but there is no flow. When a central apnea is detected, the device responds appropriately by not increasing pressure.

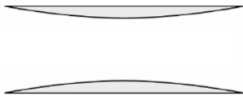

Open unrestricted airway

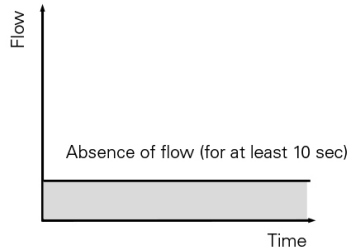

Inspiratory flow-time curve

## AutoSet for Her mode

AutoSet for Her mode is based on key aspects of ResMed's AutoSet algorithm and delivers therapeutic responses tailored to the characteristics of female OSA patients.

The AutoSet for Her is similar to ResMed's AutoSet algorithm with the following modifications:

- Reduced rate of pressure increments designed to help prevent arousals.
- Slower pressure decays.
- Treats apneas up to 12 cm H<sub>2</sub>O (12 hPa) and continues to respond to flow limitation and snore up to 20 cm H<sub>2</sub>O (20 hPa).
- Minimum pressure (Min. Pressure) that adjusts according to the frequency of apneas: If two apneas occur within a minute, the pressure reached in response to the second apnea will become the new minimum treatment pressure until the next treatment session.

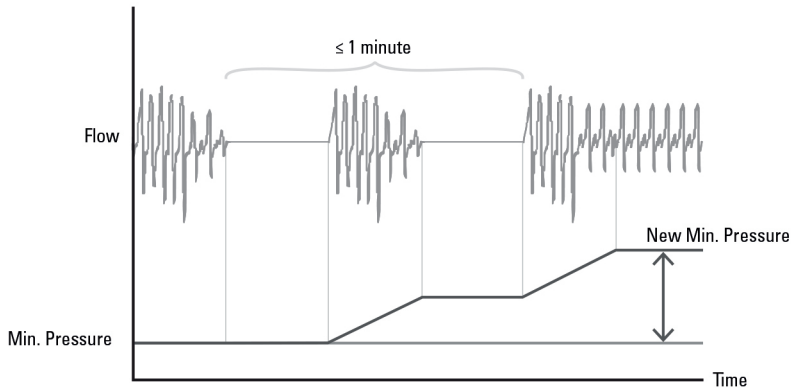

Patients who use AutoSet for Her will still get the benefits of ResMed's AutoSet technology including improved sensitivity to flow-limitation and Central Sleep Apnoea Detection with Forced Oscillation Technique.

## CPAP mode

In CPAP mode, a fixed pressure is delivered—with optional Expiratory Pressure Relief (EPR™).

## Reporting

The AirSense 10 detects Central Sleep Apnea (CSA) and Cheyne-Stokes Respiration (CSR). The Summary and Detailed Data of these parameters are available to view on ResMed patient compliance software (data availability depends on device mode and parameter measured).

### Central sleep apnea detection

Available in all modes on the AirSense 10 AutoSet Plus, AirSense 10 AutoSet for Her Plus and the AirSense 10 Elite Plus.

The device detects both obstructive and central sleep apneas (CSA). CSA detection uses the Forced Oscillation Technique (FOT) to determine the state of the patient's airway during an apnea. When an apnea has been detected, small oscillations in pressure [1 cm H<sub>2</sub>O (1 hPa) peak-to-peak at 4 Hz] are added to the current device pressure. The CSA detection algorithm uses the resulting flow and pressure (determined at the mask) to measure the airway patency.

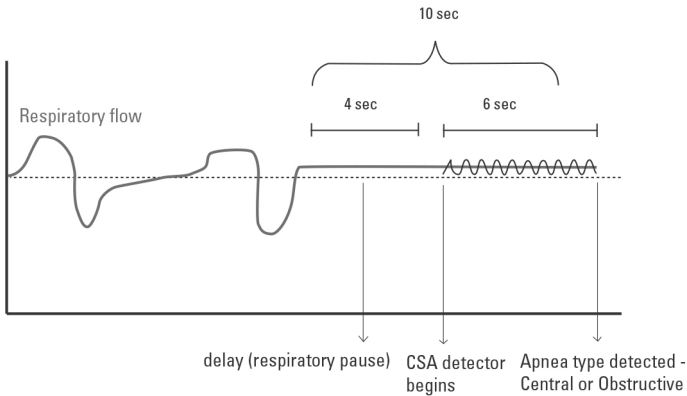

### Cheyne-Stokes respiration detection

Available in all modes on the AirSense 10 AutoSet Plus, AirSense 10 AutoSet for Her Plus and the AirSense 10 Elite Plus.

Cheyne-Stokes respiration (CSR) is a form of sleep-disordered breathing characterized by a periodic waxing and waning of respiration. The waxing periods (hyperpneas, typically 40 seconds in length) can include large gasping breaths that tend to arouse the patient while the waning periods (hypopneas or apneas, typically 20 seconds in length) cause blood oxygen desaturations.

The following example shows a typical CSR period.

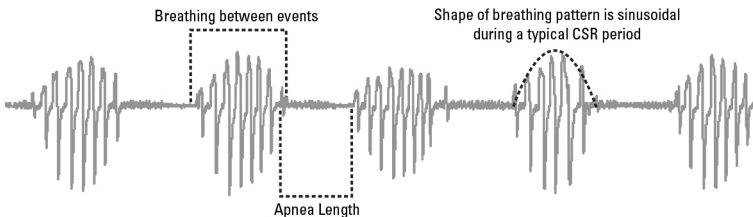

The following example suggests periodic breathing due to the frequently occurring apneas. However, when looking closely at the shape of the hyperpneas it can be seen that it is a typical OSA period.

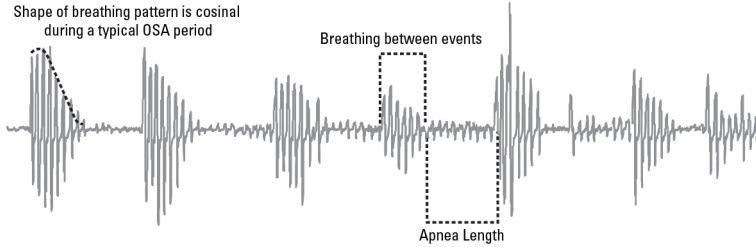

The AirSense 10 Plus device reports the time during therapy in which it detected breathing patterns indicative of CSR. It analyzes the patient's respiratory flow for apnea/hypopnea events, calculates the time between these events, and characterizes the shape of breathing between them.

### Respiratory effort related arousals reporting

Respiratory Effort Related Arousals (RERA) reporting is available on the AirSense 10 AutoSet for Her Plus in all modes.

RERAs are periods of increasing respiratory effort which are terminated by an arousal. Increasing respiratory effort will be seen as airflow limitation. These flow-based RERA events are logged and stored as summary and/or detailed data and can then be viewed in one of ResMed's patient management systems.

# Comfort features

## Ramp

Designed to make the beginning of treatment more comfortable, ramp is available in all modes.

In AutoSet mode, ramp time defines the period during which the pressure gradually increases from a lower more comfortable start pressure to the minimum treatment pressure before the auto-adjusting algorithm commences.

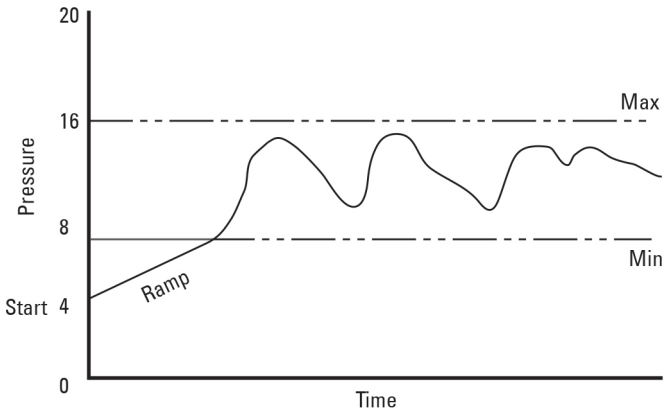

In CPAP mode, the pressure increases from a low pressure (Start Pressure) to the prescribed treatment pressure.

Ramp Time can be set to Off, 5 to 45 minutes or Auto. When Ramp Time is set to Auto, the device will detect sleep onset and then gradually increase from the start pressure to the minimum treatment pressure at a rate of 1 cm H<sub>2</sub>O (1 hPa) per minute. However, if sleep onset is not detected, the device will reach the target pressure within 30 minutes.

## Expiratory Pressure Relief

Designed to make therapy more comfortable, Expiratory Pressure Relief (EPR) maintains optimal treatment for the patient during inhalation and reduces the delivered mask pressure during exhalation.

**EPR** On—EPR is enabled.  
Off—EPR is disabled.

The following settings are only available if EPR is On:

**EPR Type** Full Time—If set to Full Time, EPR is enabled for the whole therapy session.  
Ramp Only—If set to Ramp Only, EPR is only enabled during ramp time.

**EPR Level** 1, 2, 3 cm H<sub>2</sub>O (1, 2, 3 hPa)

When EPR is enabled, the delivered pressure will not drop below a minimum pressure of 4 cm H<sub>2</sub>O (4 hPa), regardless of the settings.

## AutoSet Response

AutoSet mode (AirSense 10 AutoSet Plus device only).

For patients who are sensitive to faster changes in pressure during therapy, AutoSet Response can be set to either Standard or Soft. If set to soft, patients will receive gentler pressure rises during therapy.

Patients who use the AutoSet Response feature will still get the benefits of ResMed's AutoSet technology including improved sensitivity to flow-limitation and CSA Detection with Forced Oscillation Technique.

## Climate Control

Climate Control is an intelligent system that controls the humidifier and the ClimateLineAir heated air tubing to deliver constant, comfortable temperature and humidity levels during therapy.

Designed to prevent dryness of the nose and mouth, it maintains the set temperature and relative humidity while you sleep. Climate Control can be set to either Auto or Manual and is only available when both the ClimateLineAir and the HumidAir humidifier are attached.

### Climate Control Auto

Climate Control Auto is the recommended and default setting. Climate Control Auto is designed to make therapy as easy as possible, so there is no need to change the temperature or humidity settings.

Climate Control adjusts the humidifier output to maintain a constant, comfortable humidity level of 85% relative humidity while protecting against rainout (water droplets in the air tubing and mask).

### Tube Temperature

In Climate Control Auto there is no need to change any settings, but if the air in the mask is too warm or cold for the patient, the tube temperature can be adjusted. The Tube Temperature can be set to anywhere between 16–30°C, or turned off completely.

### Climate Control Manual

Designed to offer more flexibility and control over settings, Climate Control Manual lets the patient adjust the temperature and humidity to the setting which is most comfortable for them.

In Climate Control Manual, the Tube Temperature and the Humidity Level can be set independently however, rainout protection is not guaranteed. If rainout does occur, first try increasing the tube temperature. If the air temperature becomes too warm and rainout continues, try decreasing the humidity.

### Tube Temperature

If the air in the mask feels too warm or too cold, the patient can adjust the temperature to find what is most comfortable or turn it off completely. The Tube Temperature can be set to anywhere between 16–30°C.

The temperature sensor located at the mask end of the ClimateLineAir heated air tubing enables the system to automatically control the temperature of the air delivered to the patient. This ensures the temperature of the air delivered to the patient does not fall below the set minimum temperature, therefore maximizing breathing comfort for the patient.

## **Humidity Level**

The humidifier moistens the air and is designed to make therapy more comfortable. If the patient is getting a dry nose or mouth, turn up the humidity. If the patient is getting moisture in their mask, turn down the humidity.

The Humidity Level can be set to Off or between 1 and 8, where 1 is the lowest humidity setting and 8 is the highest humidity setting.

For each humidifier setting, the Climate Control system delivers a constant amount of water vapor, or absolute humidity (AH), to the patient's upper airway.

## **Automatic adjustment**

The humidifier and ClimateLineAir heated air tubing are controlled by the Climate Control algorithm to deliver constant humidity and temperature outputs. The system adjusts automatically to changes in:

- ambient room temperature and humidity values
- flow due to pressure changes
- flow due to mask or mouth leak.

## Setup

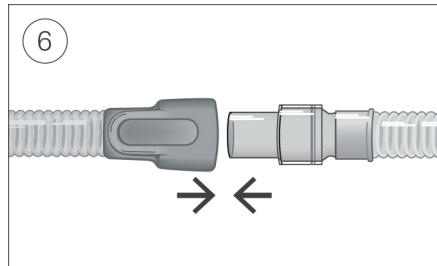
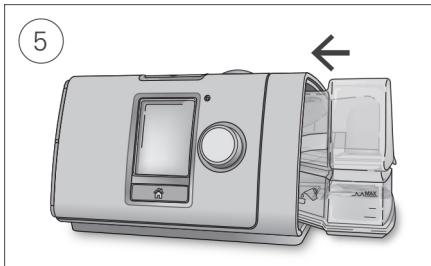
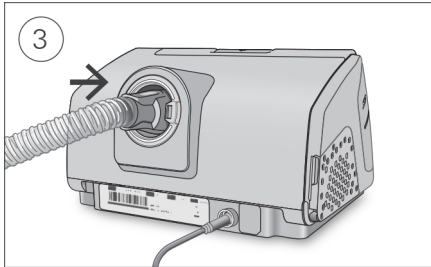
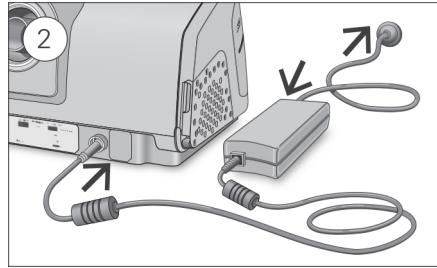
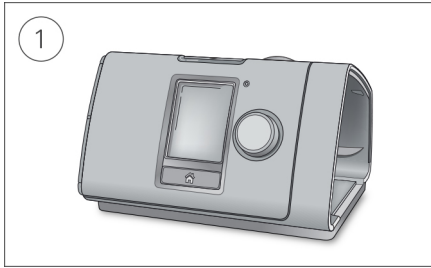

### **⚠ CAUTION**

Do not overfill the humidifier as water may enter the device and air tubing.

1. Place the device on a stable level surface.
2. Plug the power connector into the rear of the device. Connect one end of the power cord into the power supply unit and the other end into the power outlet.
3. Connect the air tubing firmly to the air outlet located on the rear of the device.
4. Open the humidifier and fill it with water up to the maximum water level mark. Do not fill the humidifier with hot water.
5. Close the humidifier and insert it into the side of the device.
6. Connect the free end of the air tubing firmly onto the assembled mask. See the mask user guide for detailed information.

Recommended masks are available on [www.resmed.com](http://www.resmed.com).



## Supplemental oxygen

The AirSense 10 Plus device is designed to be compatible with up to 4 L/min of supplemental oxygen in all modes.

At a fixed rate of supplemental oxygen flow, the inhaled oxygen concentration will vary depending on the pressure settings, patient breathing pattern, mask selection and the leak rate.

To connect supplemental oxygen to the device you need to connect an oxygen connector port. For more information on how to set up the device with supplemental oxygen, refer to the user guide supplied with that accessory.

### Notes:

- Adding oxygen may affect the delivered pressure and the accuracy of the displayed leak and minute ventilation.
- Before adding oxygen, familiarize yourself and your patient with the specific warnings relating to the use of supplemental oxygen. These can be found at the end of this guide.

## Antibacterial filters

Antibacterial filters increase resistance in the air circuit and may affect accuracy of displayed and delivered pressure, particularly at high flows.

ResMed recommends using an antibacterial filter with a low impedance [eg, 2 cm H<sub>2</sub>O (2 hPa) at 60 L/min], such as PALL (BB50T), Filter without Luer Port (4222/702) or the Filter with Side Port 24966 (4222/701). If using the Filter with Side Port, an Oxygen Connector Port is required.

## Accessing and exiting the Clinical Menu

You can access, view and set parameters relating to a patient's therapy and device configuration in the Clinical Menu.

### To access the Clinical Menu:

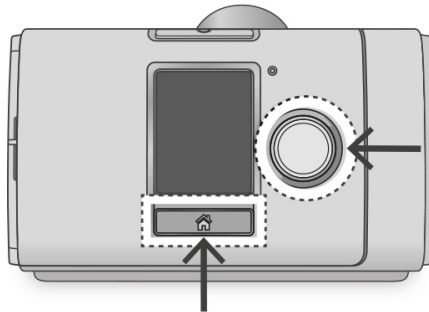

- Press and hold the dial and the Home button for three seconds.  
The Home screen is displayed with an unlock icon  in the top right corner of the screen.

### To exit the Clinical Menu:

- Press and hold the dial and the Home button for three seconds.
  - Select **Exit Clinical Menu** from the Home screen.
- The device will automatically exit the Clinical Menu after 20 minutes of inactivity.

## Adjusting the clinical settings

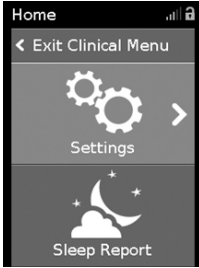

1. Access the Clinical Menu, highlight **Settings** and press the dial. The **Settings** menu is displayed.
2. Turn the dial to highlight the setting you want to adjust and then press the dial.
3. Turn the dial to adjust the setting and press the dial to save the change.

The settings can be changed in different ways depending on the type of screen:



Turn the dial to edit live in the menu.



Turn the dial to change the setting.

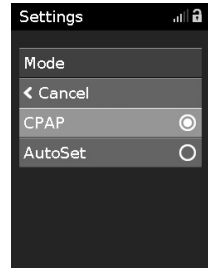

Select from a list of options.

## Setting the date and time

Before you set up a new patient and start therapy for the first time, make sure you set the correct local date and time on the device. If you set the date and time after starting therapy, you may lose patient data.

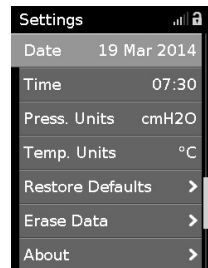
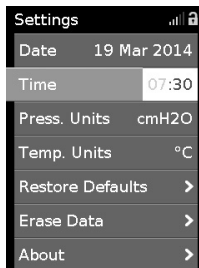

1. In **Settings** menu, select **Date** and change the setting to the correct date.
2. Select **Time** and change it to the correct local time.
3. Make sure the correct local time and date has been applied.

The AirSense 10 Plus settings must be configured for each individual patient. The settings should be periodically reassessed to ensure optimal therapy.

## Settings menu

You set all parameters relating to a patient's therapy and device configuration in the **Settings** menu.

### Therapy

Parameter	Description	AutoSet	Mode AutoSet for Her	CPAP	Range
Mode	Sets the therapy mode available on the device.	✓	✓	✓	
Min Pressure	Sets the lower limit of treatment pressure.	✓	✓		4–Max cm H <sub>2</sub> O (hPa), 0.2 cm H <sub>2</sub> O (hPa) increments
Max Pressure	Sets the upper limit of treatment pressure.	✓	✓		Min–20 cm H <sub>2</sub> O (Min–20 hPa), 0.2 cm H <sub>2</sub> O (0.2 hPa) increments
Set Pressure	Sets the fixed treatment pressure.			✓	4–20 cm H <sub>2</sub> O (4–20 hPa), 0.2 cm H <sub>2</sub> O (0.2 hPa) increments
Mask	Select the type of mask used by the patient. Refer to Mask Device Compatibility List on <a href="http://www.resmed.com">www.resmed.com</a> .	✓	✓	✓	Full Face / Nasal / Pillows

### Comfort

Parameter	Description	AutoSet	Mode AutoSet for Her	CPAP	Range
Response	Sets the rate of pressure rises during therapy.	✓			Standard / Soft
Ramp Time	If Auto is selected, the device will detect sleep onset and automatically rise to the prescribed treatment pressure.	✓	✓	✓	Off / 5–45 mins / Auto
Start Pressure	Set the pressure at the start of ramp, up to treatment pressure.	✓	✓	✓	4–Set pressure, 0.2 cm H <sub>2</sub> O (0.2 hPa) increments
EPR	Enable / disable EPR.	✓	✓	✓	On / Off
EPR Type	Available when EPR is enabled.	✓	✓	✓	Full Time / Ramp Only
EPR Level	Set the EPR value.	✓	✓	✓	1 / 2 / 3 cm H <sub>2</sub> O (1 / 2 / 3 hPa)
Climate Ctrl	Available when water tub is used and ClimateLineAir heated air tubing is connected.	✓	✓	✓	Manual / Auto

Parameter	Description	AutoSet	Mode AutoSet for Her	CPAP	Range
Tube Temp.	Set the minimum temperature of air delivered by heated air tubing such as ClimateLineAir.	✓	✓	✓	Off / 16–30°C, 1° increments
Humidity Level	Set the humidity level.	✓	✓	✓	Off / 1–8

### Accessories

Parameter	Description	Range
Tube	Select the type of air tubing used by the patient. ClimateLineAir air tubing is automatically detected when connected to the device.	SlimLine / Standard
AB filter	Select Yes if you attach an antibacterial filter.	No / Yes
View oximeter	Displayed at all times when an oximeter is connected.	18-300 BPM 0-100% SpO <sub>2</sub>

### Options

Parameter	Description	Range
Essentials	Set the level of access available to the patient.	On / Plus
SmartStart™	Enable / disable the SmartStart feature. If you enable the SmartStart feature, the device will start automatically when the patient breathes into the mask and then stop automatically when the patient removes the mask.	Off / On

### Reminders

Mask	Set a recurring reminder to the patient to replace the mask.	Off / 1–24 mths, 1 month increments
Humidifier	Set a recurring reminder to the patient to replace the humidifier.	Off / 1–24 mths, 1 month increments
Tube	Set a recurring reminder to the patient to replace the air tubing.	Off / 1–24 mths, 1 month increments
Filter	Set a recurring reminder to the patient to replace the air filter.	Off / 1–24 mths, 1 month increments

## Configuration

Parameter	Description	Selection
Language	Set the display language.  (Not all languages available in all regions.)	English /简体中文 / 繁體中文
Date	Set the current date.  If you set a new date that occurs in the past then an error message is displayed. Before this change can be made, erase the compliance data available under the Configuration menu.	DD Mmm YYYY
Time	Set the current time.  If you set a new time that occurs in the past then an error message is displayed. Before this change can be made, erase the compliance data available under the Configuration menu.	24 hours
Press. Units	Set the unit of pressure in which pressure is displayed.	cm H <sub>2</sub> O / hPa
Temp. Units	Set the temperature units.	°C
Restore Defaults	Reset to default settings (except for language, date and time).	Yes / No
Erase Data	Erase all data stored on the device and the SD card. Settings, date, time and device run hours are not affected.	Yes / No
About	View Run Hours, SN, SW, provider, type, service and signal strength of the device, CX number, humidifier and internal modem.	

# Starting therapy

1. Direct the patient to fit their mask.
2. Direct the patient to press Start/Stop, or if the SmartStart feature is enabled, direct them to breathe into their mask.

Therapy will begin and the **Sleep Report** screen is displayed.



The current treatment pressure is shown in green.

During ramp time the pressure is gradually increasing and you will see a spinning circle. Once the prescribed treatment pressure is reached, the entire circle will be green.

The screen will go black automatically after a short period of time. You can press Home or the dial to turn it back on. If power is interrupted during therapy, the device will automatically restart therapy when power is restored.

The AirSense 10 device has a light sensor that adjusts the screen brightness based on the light in the room.

# Stopping therapy

1. Direct the patient to remove the mask.
2. Direct the patient to press Start/Stop, or if SmartStart is enabled, therapy will stop automatically after a few seconds.



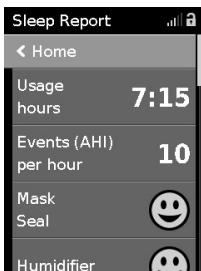

The **Sleep Report** now provides a summary of the therapy session.

# Viewing the Sleep Report

The **Sleep Report** screen shows sleep quality and mask seal status for the most recent therapy session. Turn the dial to scroll down to view more detailed usage data. The parameters displayed will depend on the therapy mode.



## Sleep Report screen parameters

Parameter	Description
Usage hours	Number of hours the device has been used during the last session.
Events (AHI) per hour	<p>Apneas and hypopneas measured per hour for one day. An apnea is when the respiratory flow decreases by more than 75% for at least 10 sec. A hypopnea is when the respiratory flow decreases to 50% for at least 10 sec. The Apnea Index (AI) and Apnea-Hypopnea Index (AHI) are calculated by dividing the total number of events that occurred by the total mask-on therapy period in hours.</p> <p><b>Note:</b> Under conditions of high leak with EPR enabled, AHI detection may not be optimal.</p>
Mask Seal	<p> Good—if the 70<sup>th</sup> percentile leak is less than 24 L/min.</p> <p> Mask needs adjustment.</p>
Humidifier	<p> Humidifier attached and functional.</p> <p> Humidifier fault; refer to troubleshooting section.</p>
<b>More Info</b>	
Period	<p>Set the time interval covered by the <b>Sleep Report</b>.</p> <p>The options are: 1 Day / 1 Week / 1 Month / 3 Months / 6 Months / 1 Year</p>
Days Used	Number of days the device has been used during the selected period or since the last compliance data was reset.
Days 4hrs+	Number of days the device has been used for more than 4 hours during the selected period or since the last compliance data was reset.
Avg. Usage	Average number of hours per day the device has been used during the selected period.
Used Hrs	Number of hours the device has been used during the selected period or since the last compliance data reset.
Pressure	Average pressure during the selected period (95 <sup>th</sup> percentile for each day; average of the 95 <sup>th</sup> percentile values for periods >1 day).
Leak	Average of the 95 <sup>th</sup> percentile values of leak during the selected period for days with usage only.
AHI	Apnea-Hypopnea Index—average AHI during the selected period. AHI and AI are calculated for times of low leak only.
Total AI	Apnea Index—average total AI during the selected period.
Central AI	Central Apnea Index—average CAI of the Days Used in the selected period.

# Cleaning and Maintenance

It is important that the AirSense 10 Plus device is cleaned regularly to ensure optimal therapy. The following sections will help with disassembling, cleaning, checking and reassembling the device.

## WARNING

Regularly clean the tubing assembly, humidifier and mask for optimal therapy and to prevent the growth of germs that can adversely affect the patient's health.

### Disassembling

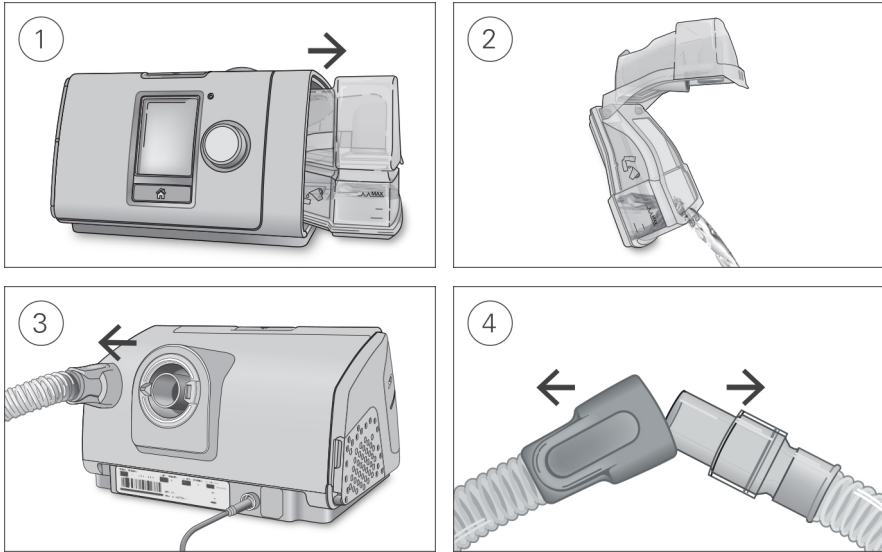

1. Hold the humidifier at the top and bottom, press it gently and pull it away from the device.
2. Open the humidifier and discard any remaining water.
3. Hold the cuff of the air tubing and gently pull it away from the device.
4. Hold both the cuff of the air tubing and the swivel of the mask, then gently pull apart.

### Cleaning

You should clean the device weekly as described. Refer to the mask user guide for detailed instructions on cleaning the mask.

1. Wash the humidifier and air tubing in warm water using mild detergent.
2. Rinse the humidifier and air tubing thoroughly and allow to dry out of direct sunlight and/or heat.
3. Wipe the exterior of the device with a dry cloth.

#### Notes:

- The humidifier may be washed in a dishwasher on the delicate or glassware cycle (top shelf only). It should not be washed at temperatures higher than 65°C.
- Do not wash the air tubing in a dishwasher or washing machine.
- Empty the humidifier daily and wipe it thoroughly with a clean, disposable cloth. Allow to dry out of direct sunlight and/or heat.



## Checking

You should regularly check the humidifier, air tubing and the air filter for any damage.

1. Check the humidifier:
  - Replace it if it is leaking or has become cracked, cloudy or pitted.
  - Replace it if the seal is cracked or torn.
  - Remove any white powder deposits using a solution of one part household vinegar to 10 parts water.
2. Check the air tubing and replace it if there are any holes, tears or cracks.
3. Check the air filter and replace it at least every six months. Replace more often if there are any holes or blockages by dirt or dust.

**To replace the air filter:**

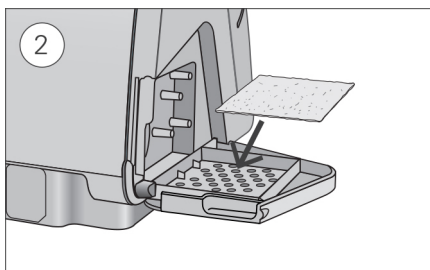
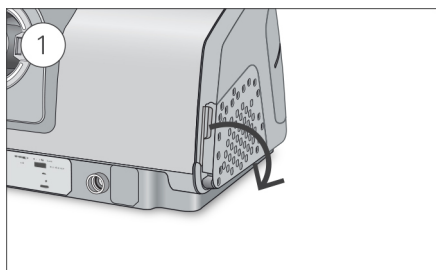

1. Open the air filter cover and remove the old air filter.  
The air filter is not washable or reusable.
2. Place a new air filter onto the air filter cover and then close it.  
Make sure the air filter is fitted at all times to prevent water and dust from entering the device.

## Reassembling

When the humidifier and air tubing are dry, you can reassemble the parts.

1. Connect the air tubing firmly to the air outlet located on the rear of the device.
2. Open the humidifier and fill it with room temperature water up to the maximum water level mark.
3. Close the humidifier and insert it into the side of the device.
4. Connect the free end of the air tubing firmly onto the assembled mask.

## Reprocessing

When the device is used for multiple patients, for example, in a sleep lab, clinic, hospital or at a health care provider, the cleanable humidifier, air outlet and air tubing should be reprocessed between each patient use.

If the cleanable humidifier or the air tubing are being used for a single user in the home, refer to the cleaning instructions in this guide or in the User Guide.

Described here are ResMed's recommended and validated procedures for cleaning and disinfecting the cleanable humidifier, air outlet and air tubing. However, the steps for disinfection vary regionally and each healthcare facility should consult its own procedures before carrying out those within this guide.

## WARNING

- ResMed cannot give any assurance that deviations from the procedures listed in this guide, and their effect on the performance of the product, will be acceptable.
- When using detergents, disinfectants or sterilization agents, always follow the manufacturer's instructions.
- Beware of electrocution. Do not immerse the device, power supply or power cord in water. If liquids are spilled into or onto the device, unplug the device and let the parts dry. Always unplug the device before cleaning and make sure that all parts are dry before plugging it back in.

## Surface disinfection

1. Wipe the exterior of the device including display, externally accessible ports, side cover, power supply unit and accessories with a disposable cloth and mild detergent or alcohol disinfectant (see list below).
2. Remove any excess disinfectant with a disposable dry cloth.

Agents recommended for surface disinfection and cleaning:

- Warm water and mild detergent eg, Teepol™ multipurpose detergent
- Window cleaner or other premixed surface detergent
- Methyl alcohol solution
- 70% Ethyl alcohol solution
- 70-90% Isopropanol solution
- 10% Bleach solution
- Isopropyl wipes
- CaviCide™
- Mikrozid®
- Actichlor™ Plus
- Terralin®.

**Note:** Agents may not be available in all regions.

## Reprocessing the air tubing and Air10 tubing elbow

### Disconnecting

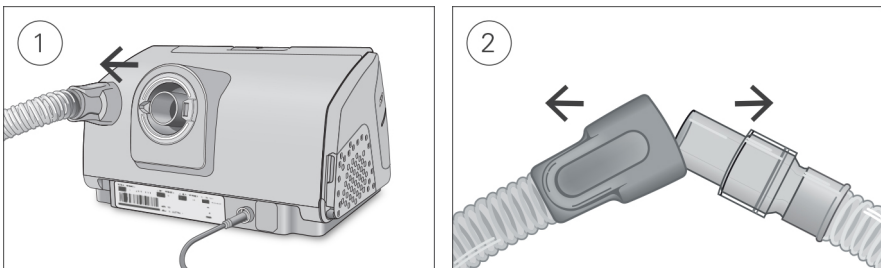

1. Hold the cuff of the air tubing and gently pull it away from the device.
2. Hold both the cuff of the air tubing and the swivel of the mask, then gently pull apart.

## Decontaminating

Before the disinfection process, each component must be cleaned and rinsed so no visible contamination is present.

1. Clean all components with a soft bristled brush for one minute while soaking in detergent solution (see table below). Pay particular attention to all crevices and cavities.
2. Run the detergent solution through the air tubing repeatedly until no contamination is visible.
3. Thoroughly rinse each component according to the detergent manufacturer's instructions.

ResMed has tested the following detergents according to the manufacturer's instructions:

Detergent	Water temperature	SlimLine / Standard	ClimateLineAir	ClimateLineAir Oxy	Air10 tubing elbow
Alconox™ (diluted at 1%)	Hot water (approx 60°C) Warm water (approx 45 to 60°C) Room temperature water (approx 21°C)	✓	✓	✓	✓
Neodisher MediZyme (diluted at 2.0%)	Warm water (approx 45 °C)	✓			
Gigazyme® (diluted at 1.0%)	Room temperature water (approx or 21°C)		✓	✓	✓

## Disinfecting

In the procedures below, only one disinfection process needs to be performed.

### High level thermal disinfection

Part	Validated number of cycles
	Hot water:75°C for 30 minutes OR 70°C for 100 minutes.
SlimLine	100
ClimateLineAir	26
ClimateLineAir Oxy	20
Standard	20
Air10 tubing elbow	26

1. Immerse the air tubing in a water bath.  
Take care that no air bubbles are trapped inside the air tubing.
2. Increase the water bath temperature to 70°C for 100 minutes, or a maximum of 75°C for 30 minutes. Higher temperatures may damage the tubing.
3. Air dry out of direct sunlight and/or heat.

## High level chemical disinfection

Part	Validated number of cycles	
	CIDEX® OPA Ortho-phthalaldehyde 0.55% for 12 minutes	Gigasept FF® 5% for 15 minutes
SlimLine	100	–
ClimateLineAir	26	26
ClimateLineAir Oxy	20	20
Standard	100	–
Air10 tubing elbow	26	26

1. Soak the air tubing/Air10 tubing elbow in a commercially available solution of a chemical sterilant. Take care that no air bubbles are trapped inside the air tubing.
2. Thoroughly rinse the air tubing/Air10 tubing elbow in drinking quality water (five liters per assembly) by immersing it completely for a minimum of one minute in duration.
3. Repeat the rinse procedure two additional times using fresh water for a total of three rinses.
4. Air dry out of direct sunlight and/or heat.

### Inspecting

Perform a visual inspection of the components. If any visible deterioration is apparent (holes, tears or cracks etc), the components should be discarded and replaced. Slight discoloration may occur and is acceptable.

### Reconnecting the air tubing

When the air tubing is dry, you can reconnect it to the device.

1. Connect the air tubing firmly to the air outlet located on the rear of the device.
2. Connect the free end of the air tubing firmly onto the assembled mask.

### Packaging and storage

Store in a dry, dust-free environment away from direct sunlight.

Storage temperature: -20°C to 60°C.

## Reprocessing the humidifier and air outlet

### Disassembling

The following instructions provide guidance on how to correctly disassemble the cleanable humidifier and the air outlet.

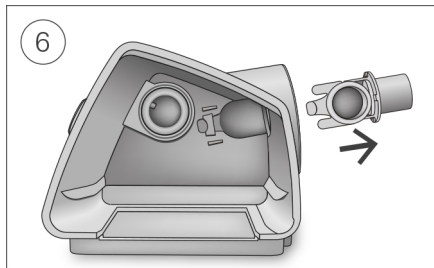
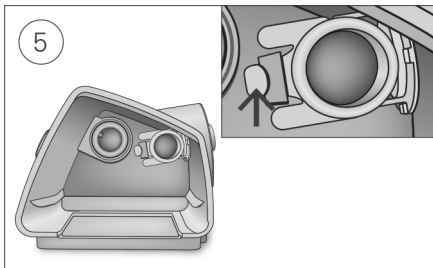
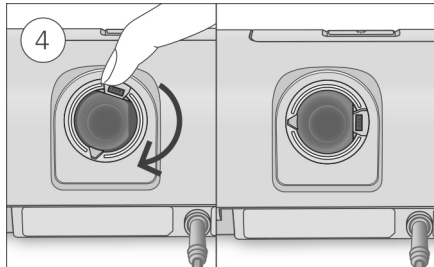
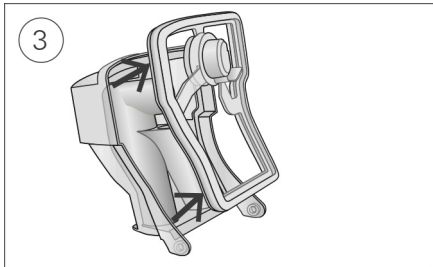
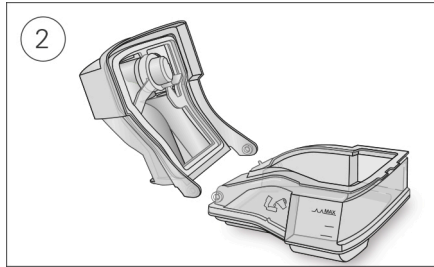
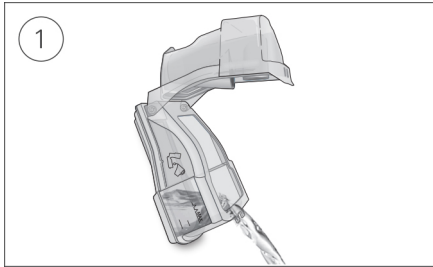

1. Remove the humidifier from the device, open it and discard any remaining water.
2. Hold the humidifier base and then fully open the humidifier lid and pull it away so that it easily detaches from the base.
3. Remove the humidifier seal from the humidifier lid by pulling it away.
4. Align the swivel so that the connector port is on the right. If the swivel is not in this position you will not be able to remove the air outlet.
5. Locate the air outlet on the inside of the device and release it by pressing the clip firmly.
6. Remove the air outlet by pulling it out through the air outlet socket at the rear of the device.

## Decontaminating

Before the disinfection process, each component must be cleaned and rinsed so no visible contamination is present.

1. Clean all components with a soft bristled brush for one minute while soaking in detergent solution (see table below). Pay particular attention to all crevices and cavities.
2. Thoroughly rinse each component according to the detergent manufacturer's instructions.

ResMed has tested the following detergents according to the manufacturer's instructions:

Detergent	Water temperature	Cleanable humidifier	Air outlet
Alconox (diluted at 1%)	Hot water (approx 60°C) Warm water (approx 45 to 60°C) Room temperature water (approx 21°C)	✓	✓
Gigazyme (diluted at 1.0%)	Room temperature water (approx 21°C)	✓	✓
Aniosyme DD1		✓	

## Disinfecting

In the procedures below, only one disinfection process needs to be performed.

### High level thermal disinfection

Part	Validated number of cycles
	Hot water: 90°C for 1 minute OR 75°C for 30 minutes OR 70°C for 100 minutes.  Due to specific regional requirements, ResMed cleanable humidifiers have been tested for disinfection (100 cycles) at 93°C for 10 minutes
Cleanable humidifier	130
Air outlet	130

1. Soak the disassembled components in a hot water bath at pasteurizing temperature. Take care that no air bubbles are trapped against the components.
2. Air dry out of direct sunlight and/or heat.

### High level chemical disinfection

Part	Validated number of cycles	
	CIDEX OPA Ortho-phthalaldehyde 0.55% for 12 minutes Gigasept FF 5% for 15 minutes	Anioxide
Cleanable humidifier	130	130
Air outlet	130	-

1. Soak the disassembled components in a commercially available solution of a chemical sterilant. Take care that no air bubbles are trapped against the components.
2. Thoroughly rinse the cleanable humidifier in drinking quality water (five liters per assembly) by immersing it completely for a minimum of one minute in duration.
3. Repeat the rinse procedure two additional times using fresh water for a total of three rinses.
4. Air dry out of direct sunlight and/or heat.

## Inspecting

Perform a visual inspection of all components. If any visible deterioration is apparent (cracking, crazing, tears, etc), the humidifier should be discarded and replaced. Slight discoloration of the silicone components may occur and is acceptable.

## Reassembling

The following instructions provide guidance on how to correctly reassemble the air outlet and the humidifier.

### To reassemble the air outlet

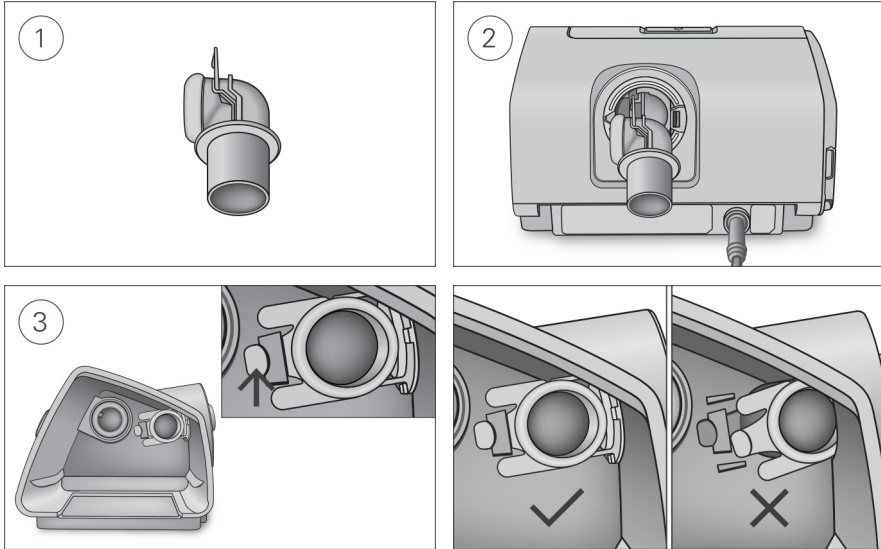

1. Hold the air outlet with the seal pointing to the left and the clip pointing forward.
2. Make sure that the air outlet is correctly aligned and insert the air outlet into the socket. It will click in place.
3. Check if the air outlet is inserted correctly as shown.

### To insert the humidifier seal:

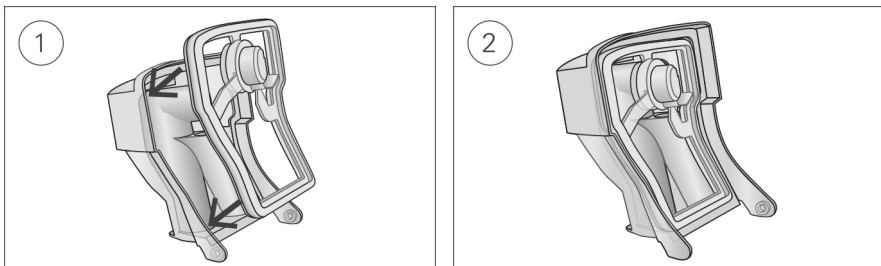

1. Place the seal into the lid.
2. Press down along all edges of the seal until it is firmly in place.

### To reassemble the humidifier lid:

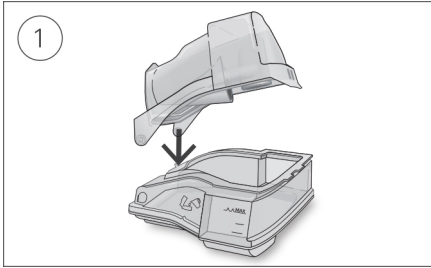

1. Insert one side of the lid into the pivot hole of the base.
2. Slide the other side down the ridge until it clicks into place.

### Packaging and storage

Store in a dry, dust-free environment away from direct sunlight.

Storage temperature: -20°C to 60°C.

## Data management and therapy compliance

The AirSense 10 Plus device stores data on the SD Card. This data can be transferred via an SD Card Reader.

### SD card

Every AirSense 10 Plus device comes with an SD card already inserted and ready to be used. Once the data is loaded into a compatible software application via the SD Card Reader, you can review and analyze data. Some software applications may also enable you to update the therapy settings and transfer them via the SD card to the device.

### To remove the SD card:

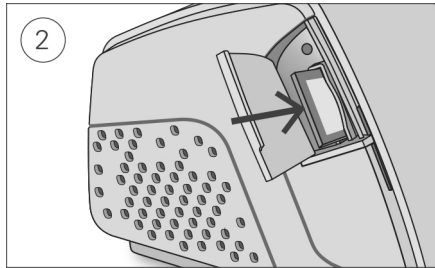
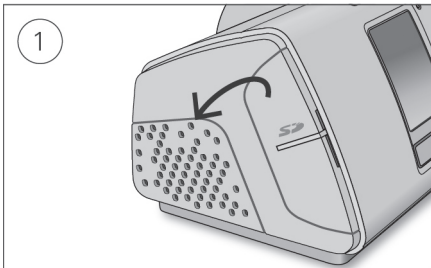

1. Open the SD card cover.
2. Push in the SD card to release it. Remove the SD card from the device.

Do not remove the SD card from the device when the SD light is flashing.



### To insert the SD card:

1. Open the SD card cover.
2. Push the SD card into the device until it clicks.  
The following message is briefly displayed: **Preparing SD card, do not remove power or your card.**

## Data storage

The AirSense 10 Plus device stores summary data such as AHI, Total Hours Used and Leak. Detailed data such as snore and pulse rate, as well as high resolution flow and pressure data are stored on the SD card.

Data can be transmitted to compliance management software via SD card. The different ways of transmitting data are detailed in the table below.

Type of data	Transmission method SD Card	Sessions stored
Summary data (compliance data)	✓	365
Detailed data	✓	Limited by usage and SD card storage capacity
High resolution flow and pressure data (25 Hz - every 40 ms)	✓	

## Managing patient care

The following section has been provided to assist you with managing your patients' care.

### Patient menu

In the patient menu there are two types of access levels, Essentials and Essentials Plus.

Essentials is designed to make the device interaction and menu navigation easier for patients. It is a simple choice for patients who do not want to worry about settings or menu navigation. It provides access to the most important comfort features such as Ramp Time, Humidity Level (if water tub available) and Run Mask Fit.

However, by enabling Essentials Plus you can allow highly engaged patients to access additional features for control over more of their therapy settings, including changing their mask type, EPR (if available), SmartStart and Run Warmup (if water tub available).

Essentials Plus can be enabled via the Settings menu. For more information on the patient menu, see the User Guide.

### Traveling

Patients can take their AirSense 10 Plus device wherever they go. Advise patients of the following:

- Use the travel bag provided to prevent damage to the device.
- Empty the humidifier and pack it separately in the travel bag.
- Make sure the patient has the appropriate power cord for the region of travel. For information on purchasing, contact your ResMed representative.
- When using an external battery, turn off the humidifier in order to maximize battery life. Do this by turning the **Humidity Level** to Off.

## Traveling by plane

The AirSense 10 Plus device may be taken on board as carry-on luggage. Medical devices do not count toward the carry-on luggage limit.

The AirSense 10 Plus device can be used on a plane as it meets the Federal Aviation Administration (FAA) requirements. Air travel compliance letters can be downloaded and printed from [www.resmed.com](http://www.resmed.com).

When using the device on a plane:

- Make sure the humidifier is completely empty and inserted into the device. The device will not work without the humidifier inserted.
- Turn on **Airplane Mode** (for instructions refer to the User Guide).

## CAUTION

**Do not use the device with water in the humidifier on a plane due to the risk of inhalation of water during turbulence.**

## Troubleshooting



If there is a problem, try the following suggestions. If you are not able to fix the problem, contact your local ResMed dealer or ResMed office. Do not open the device.

### General troubleshooting

Problem/possible cause	Solution
<b>Air is leaking from around the mask</b>	
Mask may be fitted incorrectly.	Make sure the mask is fitted correctly. See mask user guide for fitting instructions or use the Mask Fit function to check mask fit and seal.
<b>The patient is getting a dry or blocked nose</b>	
Humidity level may be set too low.	Adjust the Humidity Level. If you have ClimateLineAir heated air tubing, see the ClimateLineAir user guide.
<b>There are droplets of water in the mask and air tubing</b>	
Humidity level may be set too high.	Adjust the Humidity Level. If you have ClimateLineAir heated air tubing, see the ClimateLineAir user guide.
<b>The patient is getting a very dry mouth</b>	
Air may be escaping through the patient's mouth.	Increase the Humidity Level. The patient may need a chin strap to keep the mouth closed or a full face mask.
<b>The patient feels that too much air is being delivered from the device</b>	
Ramp may be turned off.	Use the Ramp Time option.

Problem/possible cause	Solution
<b>The patient feels that not enough air is being delivered from the device</b>	
Ramp may be in progress.	Wait for air pressure to build up or turn Ramp Time off.
Ramp start pressure may be too low.	Increase Ramp start pressure.
<b>No display</b>	
Backlight on the screen may have turned off. It turns off automatically after a short period of time.	Press Home or the dial to turn it back on.
Power may not be connected.	Connect the power supply and make sure the plug is fully inserted.
<b>Therapy has stopped, but the device is still blowing air</b>	
Device is cooling down.	Device blows a small amount of air in order to avoid condensation in the air tubing. It will stop automatically after 30 minutes.
<b>Humidifier is leaking</b>	
Humidifier may not be assembled correctly.	Check for damage and reassemble the humidifier correctly.
Humidifier may be damaged or cracked.	Replace the humidifier.
<b>Sleep report for the humidifier indicates .</b>	
Humidifier fault	Contact your local ResMed dealer or ResMed office.
<b>SmartStart is enabled, but the device does not automatically start when the patient breathes into their mask</b>	
Breath is not deep enough to trigger SmartStart.	To start therapy, take a deep breath in and out through the mask, before breathing normally.  Press Start.
There is excessive leak.	Adjust the mask and headgear.  Air tubing may not be connected properly. Connect firmly at both ends.
<b>SmartStart is enabled, but the device does not automatically stop when the patient removes their mask</b>	
Incompatible mask being used.	Only use equipment recommended by ResMed.  Contact ResMed or see <a href="http://www.resmed.com">www.resmed.com</a> for more information.  If the patient is using a nasal pillows mask with set pressure less than 7 cm H <sub>2</sub> O (7 hPa), SmartStart will not work and should be disabled.

## Device messages

Device message/possible cause	Solution
<b>High leak detected, check your water tub, tub seal or side cover</b>	
Humidifier may not be inserted properly.	Make sure the humidifier is correctly inserted.
Humidifier seal may not be inserted properly.	Open the humidifier and make sure that the seal is correctly inserted.
<b>High leak detected, connect your tubing</b>	
Air tubing may not be connected properly.	Make sure the air tubing is firmly connected at both ends.
Mask may be fitted incorrectly.	Make sure the mask is fitted correctly. See mask user guide for fitting instructions or use the Mask Fit function to check mask fit and seal.
<b>Tubing blocked, check your tubing</b>	
Air tubing may be blocked.	Check the air tubing and remove any blockages. Press the dial to clear the message and then press Start/Stop to restart the device.
<b>Read only card, please remove, unlock and re-insert SD card</b>	
SD card switch may be in the lock (read-only) position.	Move the switch on the SD Card from the lock position  to the unlock position  and then re-insert it.
<b>Date and time can not be set in the past</b>	
Date and time were not set before data was recorded.	Select Erase Data in <b>Settings</b> . Once the data is erased, set the correct local date and time.
<b>System fault, refer to user guide, Error 004</b>	
Device may have been left in a hot environment.	Allow to cool before re-use. Disconnect the power supply and then reconnect it to restart the device.
Air filter may be blocked.	Check the air filter and replace it if there are any blockages. Disconnect the power supply and then reconnect it to restart the device.
Air tubing may be blocked.	Check the air tubing and remove any blockages. Press the dial to clear the message and then press Start/Stop to restart the device.
There may be water in the air tubing.	Empty the water from the air tubing. Disconnect the power supply and then reconnect it to restart the device.
<b>All other error messages, for example, System fault, refer to user guide, Error 0XX</b>	
An unrecoverable error has occurred on the device.	Contact your local ResMed dealer or ResMed office. Do not open the device.

## General warnings and cautions

### WARNING

- Make sure that you arrange the air tubing so that it will not twist around the head or neck.
- Make sure the power cord and plug are in good condition and the equipment is not damaged.
- Keep the power cord away from hot surfaces.
- If you notice any unexplained changes in the performance of the device, if it is making unusual sounds, if the device or the power supply are dropped or mishandled, or if the enclosure is broken, discontinue use and contact your care provider or your ResMed Service Center.
- Do not open or modify the device. There are no user serviceable parts inside. Repairs and servicing should only be performed by an authorized ResMed service agent.
- Beware of electrocution. Do not immerse the device, power supply or power cord in water. If liquids are spilled into or onto the device, unplug the device and let the parts dry. Always unplug the device before cleaning and make sure that all parts are dry before plugging it back in.
- Supplemental oxygen must not be used while smoking or in the presence of an open flame.
- Always make sure that the device is turned on and airflow generated before the oxygen supply is turned on. Always turn the oxygen supply off before the device is turned off, so that unused oxygen does not accumulate within the device enclosure and create a risk of fire.
- Do not perform any maintenance tasks while the device is in operation.
- The device should not be used adjacent to or stacked with other equipment. If adjacent or stacked use is necessary, the device should be observed to verify normal operation in the configuration in which it will be used.
- The use of accessories other than those specified for the device is not recommended. They may result in increased emissions or decreased immunity of the device.
- Regularly check the antibacterial filter for signs of moisture or other contaminants, particularly during nebulization or humidification. Failure to do so could result in increased breathing system resistance.

### CAUTION

- Use only ResMed parts and accessories with the device. Non-ResMed parts may reduce the effectiveness of the treatment and/or damage the device.
- Use only vented masks recommended by ResMed or by the prescribing doctor with this device. Fitting the mask without the device blowing air can result in rebreathing of exhaled air. Make sure that the mask vent holes are kept clear and unblocked to maintain the flow of the fresh air into the mask.
- Be careful not to place the device where it can be bumped or where someone is likely to trip over the power cord.
- Blocking the air tubing and/or air inlet of the device while in operation could lead to overheating of the device.
- Keep the area around the device dry, clean and clear of anything (eg, clothes or bedding) that could block the air inlet or cover the power supply unit.
- Do not place the device on its side as water might get into the device.
- Incorrect system setup may result in incorrect mask pressure reading. Ensure the system is correctly set up.

- Do not use bleach, chlorine, alcohol, or aromatic-based solutions, moisturizing or antibacterial soaps or scented oils to clean the device, the humidifier or air tubing. These solutions may cause damage or affect the humidifier performance and reduce the life of the products.
- If you use the humidifier, always place the device on a level surface lower than the patient's head to prevent the mask and air tubing from filling with water.
- Do not overfill the humidifier as water may enter the device and air tubing.
- Leave the humidifier to cool for ten minutes before handling to allow the water to cool and to make sure that the humidifier is not too hot to touch.
- Make sure that the humidifier is empty before transporting the device.

## Technical specifications

Units are expressed in cm H<sub>2</sub>O and hPa. 1 cm H<sub>2</sub>O is equal to 0.98 hPa.

### 90W power supply unit

AC input range:	100–240V, 50–60Hz 1.0–1.5A, Class II 115V, 400Hz 1.5A, Class II (nominal for aircraft use)
DC output:	24V  3.75A
Typical power consumption:	53W (57VA)
Peak power consumption:	104W (108VA)

### Environmental conditions

Operating temperature:	+5°C to +35°C <b>Note:</b> The air flow for breathing produced by this therapy device can be higher than the temperature of the room. Under extreme ambient temperature conditions (40°C) the device remains safe.
Operating humidity:	10 to 95% relative humidity, non-condensing
Operating altitude:	Sea level to 2,591 m; air pressure range 1013 hPa to 738 hPa
Storage and transport temperature:	-20°C to +60°C
Storage and transport humidity:	5 to 95% relative humidity, non-condensing

### Electromagnetic compatibility

The AirSense 10 complies with all applicable electromagnetic compatibility requirements (EMC) according to IEC 60601-1-2:2014, for residential, commercial and light industry environments. It is recommended that mobile communication devices are kept at least 1 m away from the device.

Information regarding the electromagnetic emissions and immunity of this ResMed device can be found on [www.resmed.com/downloads/devices](http://www.resmed.com/downloads/devices)

### Classification: IEC 60601-1:2005+A1:2012

Class II (double insulation), Type BF, Ingress protection IP22.

### Sensors

Pressure sensor:	Internally located at device outlet, analog gauge pressure type, -5 to +45 cm H <sub>2</sub> O (-5 to +45 hPa)
Flow sensor:	Internally located at device inlet, digital mass flow type, -70 to +180 L/min

### Maximum single fault steady pressure

Device will shut down in the presence of a single fault if the steady state pressure exceeds:

30 cm H<sub>2</sub>O (30 hPa) for more than 6 sec or 40 cm H<sub>2</sub>O (40 hPa) for more than 1 sec.

## Sound

Pressure level measured according to ISO 80601-2-70:2015 (CPAP mode):

SlimLine: 25 dBA with uncertainty of 2 dBA

Standard: 25 dBA with uncertainty of 2 dBA

SlimLine or Standard and humidification: 27 dBA with uncertainty of 2 dBA

Power level measured according to ISO 80601-2-70:2015 (CPAP mode):

SlimLine: 33 dBA with uncertainty of 2 dBA

Standard: 33 dBA with uncertainty of 2 dBA

SlimLine or Standard and humidification: 35 dBA with uncertainty of 2 dBA

Declared dual-number noise emission values in accordance with ISO 4871:1996.

---

## Physical - device and humidifier

Dimensions (H x W x D): 116 mm x 255 mm x 150 mm

Air outlet (complies with ISO 5356-1:2004): 22 mm

Weight (device and cleanable humidifier): 1208 g

Housing construction: Flame retardant engineering thermoplastic

Water capacity: To maximum fill line 380 mL

Cleanable humidifier - material: Injection molded plastic, stainless steel and silicone seal

---

## Temperature

Maximum heater plate: 68°C

Cut-out: 74°C

Maximum gas temperature: ≤ 41°C

---

## Air filter

Standard: Material: Polyester non woven fiber  
Average arrestance: >75% for ~7 micron dust

Hypoallergenic: Material: Acrylic and polypropylene fibers in a polypropylene carrier  
Efficiency: >98% for ~7-8 micron dust; >80% for ~0.5 micron dust

---

## Aircraft use

ResMed confirms that device meets the Federal Aviation Administration (FAA) requirements (RTCA/DO-160, section 21, category M) for all phases of air travel.

---

## Declaration of Conformity (DoC to the R&TTE Directive)

ResMed declares that the AirSense 10 device is in compliance with the essential requirements and other relevant provisions of Directive 1999/5/EC. A copy of the declaration of conformity (DoC) can be found on [www.ResMed.com/ProductSupport](http://www.ResMed.com/ProductSupport).

---

## Operating pressure range

AutoSet, AutoSet For Her, CPAP: 4 to 20 cm H<sub>2</sub>O (4 to 20 hPa)

---

## Supplemental oxygen

Maximum flow: 4 L/min

---

### Pneumatic flow path

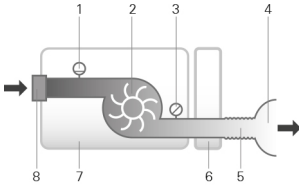

1. Flow sensor
2. Blower
3. Pressure sensor
4. Mask
5. Air tubing
6. Humidifier
7. Device
8. Inlet filter

### Design life

Device, power supply unit:	5 years
Cleanable humidifier:	2.5 years
Air tubing:	6 months

### Humidifier performance

Mask Pressure cm H <sub>2</sub> O (hPa)	RH output % at 17°C ambient temperature		RH output % at 22°C ambient temperature		Nominal system output AH <sup>1</sup> , BTPS <sup>2</sup>	
	Setting 4	Setting 8	Setting 4	Setting 8	Setting 4	Setting 8
4	85	100	6		6	>10
10	85	100	6		6	>10
20	85	90	6		6	>10

<sup>1</sup> AH - Absolute Humidity in mg/L

<sup>2</sup> BTPS - Body Temperature Pressure Saturated

### Air tubing

Air tubing	Material	Length	Inner diameter
ClimateLineAir	Flexible plastic and electrical components	2 m	15 mm
ClimateLineAir Oxy	Flexible plastic and electrical components	1.9 m	19 mm
SlimLine	Flexible plastic	1.8 m	15 mm
Standard	Flexible plastic	2 m	19 mm

Heated air tubing temperature cut-out: ≤ 41°C

### Notes:

- The manufacturer reserves the right to change these specifications without notice.
- The electrical connector end of the heated air tubing is only compatible with the air outlet at the device end and should not be fitted to the mask.
- Do not use electrically conductive or antistatic air tubing.
- The temperature and relative humidity settings displayed are not measured values.



## Displayed values

Value	Range	Display resolution
Pressure sensor at air outlet:		
Mask pressure	4–20 cm H <sub>2</sub> O (4–20 hPa)	0.1 cm H <sub>2</sub> O (0.1 hPa)
Flow derived values:		
Leak	0–120 L/min	1 L/min
Value	Accuracy	
Pressure measurement <sup>1</sup> :		
Mask pressure <sup>2</sup>	±[0.5 cm H <sub>2</sub> O (0.5 hPa) + 4% of measured value]	
Flow and flow derived values <sup>1</sup> :		
Flow	±6 L/min or 10% of reading, whichever is greater, at 0 to 150 L/min positive flow	
Leak <sup>2</sup>	±12 L/min or 20% of reading, whichever is greater, 0 to 60 L/min	

<sup>1</sup> Results are expressed as STPD (Standard Temperature and Pressure, Dry).

<sup>2</sup> Accuracy may be reduced by the presence of leaks, supplemental oxygen, tidal volumes <100 mL or minute ventilation <3 L/min.

## Measurement system uncertainties

In accordance with ISO 80601-2-70:2015 the measurement uncertainty of the manufacturer's test equipment is:

For measures of flow	± 1.5 L/min or ± 2.7% of reading (whichever is greater)
For measures of volume (< 100 mL)	± 5 mL or 6% of reading (whichever is greater)
For measures of volume (≥ 100 mL)	± 20 mL or 3% of reading (whichever is greater)
For measures of pressure	± 0.15 cm H <sub>2</sub> O (0.15 hPa)
For measures of time	± 10 ms

## Pressure accuracy

### Maximum static pressure variation at 10 cm H<sub>2</sub>O (10 hPa) according to ISO 80601-2-70:2015

	Standard air tubing	SlimLine air tubing
Without humidification	± 0.5 cm H <sub>2</sub> O (± 0.5 hPa)	± 0.5 cm H <sub>2</sub> O (± 0.5 hPa)
With humidification	± 0.5 cm H <sub>2</sub> O (± 0.5 hPa)	± 0.5 cm H <sub>2</sub> O (± 0.5 hPa)

### Maximum dynamic pressure variation according to ISO 80601-2-70:2015

Device without humidification and Standard air tubing / Device with humidification and Standard air tubing

Pressure [cm H <sub>2</sub> O (hPa)]	10 BPM	15 BPM	20 BPM
4	0.5 / 0.5	0.5 / 0.5	0.8 / 0.8
8	0.5 / 0.5	0.5 / 0.5	0.8 / 0.8
12	0.5 / 0.5	0.5 / 0.5	0.8 / 0.8
16	0.5 / 0.5	0.5 / 0.5	0.8 / 0.8
20	0.5 / 0.5	0.5 / 0.5	0.8 / 0.8

Device without humidification and SlimLine air tubing / Device with humidification and SlimLine air tubing

Pressure [cm H <sub>2</sub> O (hPa)]	10 BPM	15 BPM	20 BPM
4	0.5 / 0.5	0.5 / 0.5	0.8 / 0.8
8	0.5 / 0.5	0.5 / 0.5	0.8 / 0.8
12	0.5 / 0.5	0.5 / 0.5	0.8 / 0.8
16	0.5 / 0.5	0.5 / 0.5	0.8 / 0.8
20	0.5 / 0.5	0.5 / 0.5	0.8 / 0.8

## Flow (maximum) at set pressures

The following are measured accordingly to ISO 80601-2-70:2015 at the end of the specified air tubing:

Pressure	AirSense 10 Plus and Standard	AirSense 10 Plus, humidification and Standard	AirSense 10 Plus and SlimLine	AirSense 10 Plus, humidification and ClimateLineAir
cm H <sub>2</sub> O (hPa)	L/min	L/min	L/min	L/min
4	180	143	162	151
8	168	135	151	142
12	157	136	140	135
16	144	134	128	121
20	131	123	117	109

## Symbols

The following symbols may appear on the product or packaging.

Read instructions before use. Indicates a warning or caution. Follow instructions before use. Manufacturer. **EC REP** European Authorized Representative. **LOT** Batch code.

**REF** Catalog number. **SN** Serial number. **DN** Device number. On / Off. Device weight.

**IP22** Protected against finger sized objects and against dripping water when tilted up to 15 degrees from specified orientation. Direct current. Type BF applied part. Class II equipment. Humidity limitation. Temperature limitation. Non-ionising radiation.

Contains no China environmental hazardous substances 10/20 years of China environmental protection use period. **Rx Only** Prescription only (In the US, Federal law restricts these devices to sale by or on the order of a physician). **MAX** Maximum water level.

Use distilled water only. Operating altitude. Atmospheric pressure limitation.

Complies with RTCA DO-160 section 21, category M.



### Environmental information

This device should be disposed of separately, not as unsorted municipal waste. To dispose of your device, you should use appropriate collection, reuse and recycling systems available in your region. The use of these collection, reuse and recycling systems is designed to reduce pressure on natural resources and prevent hazardous substances from damaging the environment.

If you need information on these disposal systems, please contact your local waste administration. The crossed-bin symbol invites you to use these disposal systems. If you require information on collection and disposal of your ResMed device please contact your ResMed office, local distributor or go to [ResMed.com/environment](http://ResMed.com/environment).

## Servicing

The AirSense 10 Plus device is intended to provide safe and reliable operation when operated in accordance with the instructions provided by ResMed. ResMed recommends that the AirSense 10 Plus device be inspected and serviced by an authorized ResMed Service Centre if there is any sign of wear or concern with device function. Otherwise, service and inspection of the products generally should not be required during their design life.

## Limited warranty

ResMed Ltd (hereafter 'ResMed') warrants that your ResMed product shall be free from defects in material and workmanship from the date of purchase for the period specified below.

Product	Warranty period
<ul style="list-style-type: none"><li>• Mask systems (including mask frame, cushion, headgear and tubing)—excluding single-use devices</li><li>• Accessories—excluding single-use devices</li><li>• Flex-type finger pulse sensors</li><li>• Humidifier water tubs</li></ul>	90 days
<ul style="list-style-type: none"><li>• Batteries for use in ResMed internal and external battery systems</li></ul>	6 months
<ul style="list-style-type: none"><li>• Clip-type finger pulse sensors</li><li>• CPAP and bilevel device data modules</li><li>• Oximeters and CPAP and bilevel device oximeter adapters</li><li>• Humidifiers and humidifier cleanable water tubs</li><li>• Titration control devices</li></ul>	1 year
<ul style="list-style-type: none"><li>• CPAP, bilevel and ventilation devices (including external power supply units)</li><li>• Battery accessories</li><li>• Portable diagnostic/screening devices</li></ul>	2 years

This warranty is only available to the initial consumer. It is not transferable.

If the product fails under conditions of normal use, ResMed will repair or replace, at its option, the defective product or any of its components.

This Limited Warranty does not cover: a) any damage caused as a result of improper use, abuse, modification or alteration of the product; b) repairs carried out by any service organization that has not been expressly authorized by ResMed to perform such repairs; c) any damage or contamination due to cigarette, pipe, cigar or other smoke; and d) any damage caused by water being spilled on or into an electronic device.

Warranty is void on product sold, or resold, outside the region of original purchase.

Warranty claims on defective product must be made by the initial consumer at the point of purchase.

This warranty replaces all other expressed or implied warranties, including any implied warranty of merchantability or fitness for a particular purpose. Some regions or states do not allow limitations on how long an implied warranty lasts, so the above limitation may not apply to you.

ResMed shall not be responsible for any incidental or consequential damages claimed to have resulted from the sale, installation or use of any ResMed product. Some regions or states do not allow the exclusion or limitation of incidental or consequential damages, so the above limitation may not apply to you.

This warranty gives you specific legal rights, and you may also have other rights which vary from region to region. For further information on your warranty rights, contact your local ResMed dealer or ResMed office.



**ResMed Ltd**

**MANUFACTURER** 1 Elizabeth Macarthur Drive Bella Vista NSW 2153 Australia

See [www.resmed.com](http://www.resmed.com) for other ResMed locations worldwide. For patent and other intellectual property information, see [www.resmed.com/ip](http://www.resmed.com/ip). Air10, AirSense, AutoSet, ClimateLine, EPR, HumidAir, SlimLine and SmartStart are trademarks and/or registered trademarks of the ResMed family of companies. Actichlor is a trademark of Ecolab US Inc. Alconox is a trademark of Alconox Inc. Cavicide is a registered trademark of Metrex Research, LLC. CIDEX is a registered trademark of Advanced Sterilization Products, Division of Ethicon US, LLC. Mikrozid and Terralin are trademarks of Schülke & Mayr GmbH. Neodisher MediZym is a trademark of Chemische Fabrik Dr Weigert GmbH & Co. KG. SD Logo is a trademark of SD-3C, LLC. Teepol is a trademark of Shell Chemical Co. © 2017 ResMed Ltd. 378759/4 2017-11

ResMed.com